

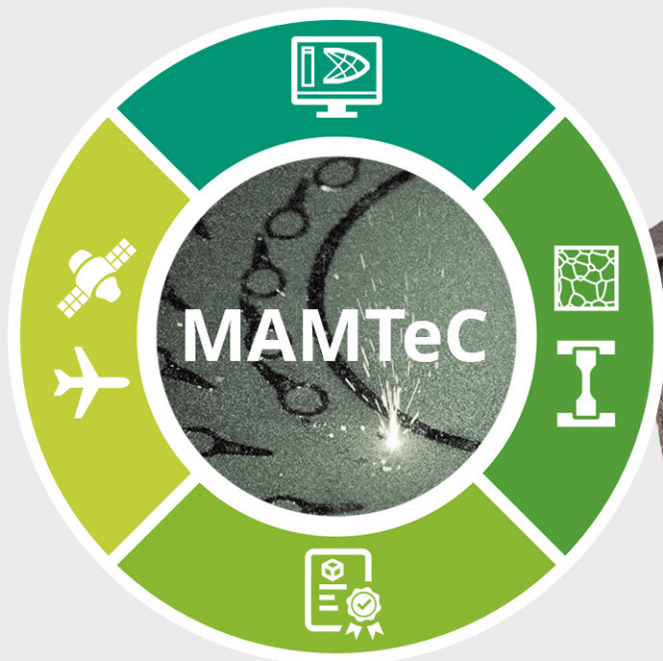

Accelerating  
the future  
of aerospace

## NLR-MAMTeC

Bringing Additive Manufacturing down to earth



Royal NLR - Netherlands Aerospace Centre



# Royal NLR

## NLR Metal Additive Manufacturing Technology Centre - MAMTeC

NLR-MAMTeC is the independent Metal Additive Manufacturing Technology Centre in the Netherlands and it is part of the Royal Netherlands Aerospace Centre (NLR). More than 50 years of materials experience in aerospace applications is applied, offering assistance through technology development and product innovation. Our multidisciplinary team can help you develop the process more efficiently, from optimised parameters, post-processing approaches, evaluation of mechanical properties, design optimisation and process simulation through to the qualification and certification of metal-additive manufacturing (AM) products.

Some of the highlights at NLR-MAMTeC are the AM process development for challenging materials such as magnesium alloys and the development of a process-based qualification approach based on simulation and the application of variable process parameters.

To let you get to know more about NLR and our AM activities, we have selected some of the research projects and capabilities that we have developed, both alone and together with partners.

We hope you enjoy reading and discovering more about NLR.

NLR – Royal Netherlands Aerospace Centre

# From process optimisation to industrialisation

Qualified processes and certified parts are essential for successful and widespread applications of metal additive manufactured (AM) parts, for instance in components for aerospace, oil & gas, high-tech/high-spec industry and defence. These markets benefit well from the reduced weight, increased efficiency and reduced lead times that metal AM can offer. NLR works on AM process optimisation, assesses material properties, designs components and builds parts up to the level of full-scale prototypes. Spanning the entire spectrum of process and product development is what makes NLR unique. The core of NLR-MAMTeC is an enthusiastic multidisciplinary team working in an environment with expertise and facilities that are essential for building up advanced metal AM knowledge and skills.

## MODELLING & SIMULATION

We apply in-depth modelling and simulation knowledge to take metal AM to the next level. Design tools including topology optimisation are applied to get the maximum benefit out of AM for weight reduction and performance. NLR applies thermomechanical simulation expertise to predict thermal variations, residual stresses and deformations. A new development is the generation of optimised variable process parameters to prevent large temperature variations and produce homogeneous materials with consistent mechanical properties.

## MATERIALS

More than 50 years of materials experience in aerospace applications is combined with in-depth metal AM expertise to establish optimised process parameters and post-processing methods. This expertise is also used for developing AM for novel and challenging alloys and multi-materials. The development of metal AM material knowledge is backed up by advanced inspection methods, analysis techniques and mechanical testing facilities.

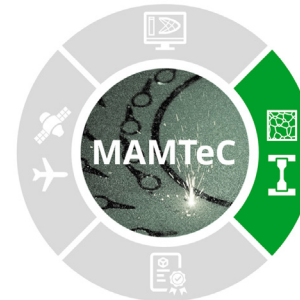

## QUALIFICATION & CERTIFICATION

NLR has a long track record in qualification and certification for aerospace applications. This experience is applied in further development of qualification approaches for AM. Current AM qualification approach is part-based, meaning that the qualification is only valid for a specific part design that is produced with a fixed material on a specific machine using fixed process parameters. A process-based qualification approach needs to be developed if the full potential of AM is to be utilised. This requires in-depth understanding of processes-material relationships and the relationship with the part's design. NLR-MAMTeC is working on new virtual qualification and certification approaches for AM.

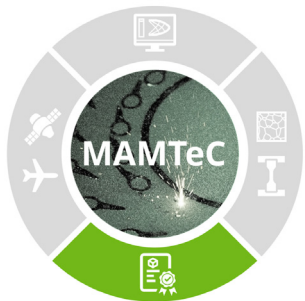

## APPLICATIONS

NLR's research infrastructure consists of a wide variety of facilities and equipment that constitutes the backbone for NLR's applied research. Metal AM has found its way to many of these different application areas within NLR. Examples are:

- Low-weight structural applications
- Combinations with fibre-reinforced composite materials
- Wind tunnel models
- Thermal control applications, including heat exchangers
- Acoustic liner applications
- Hydrogen applications
- Drones





**Project partner**

Boeing  
Project lead: Royal NLR  
Duration: 2014-2021

# Magnesium LPBF to manufacture light-weight components for vertical lift applications

The objective of this research project was to demonstrate the capability to produce high-quality magnesium products for vertical lift applications by Laser Powder Bed Fusion (LPBF). Magnesium has become the preferred material for vertical lift transmission casings due to the combination of low density and high specific strength. Magnesium LPBF therefore offers a great deal of potential for vertical lift applications. Internal channels for lubrication and/or cooling can be optimised and substantial additional weight reductions can be achieved compared to cast products.

## THE CHALLENGE

Magnesium is a challenging material to process in LPBF due to its low boiling point and high reactivity with oxygen. Considerably more fumes are generated during LPBF processing of magnesium alloys than with other alloys. These fumes can absorb or deflect the laser beam, resulting in an unstable process.

## THE SOLUTION

NLR-MAMTeC analysed and improved the inert gas flow configuration so that the extraction of fumes was made more effective. This improvement was found to be an important step in making LPBF processing of magnesium possible.

## WHAT WE DID?

An efficient optimisation approach was applied for selecting the process parameters. Benchmark parts were produced for evaluating design rules for printing magnesium parts. Demonstrator parts were successfully produced based on a representative lightweight component for a vertical lift application. A fine homogeneous microstructure was found at the melt-pool and grain scale.

# MovAbles for Next generation Aircraft (MANTA)

## THE CHALLENGE

The objective was to manufacture three Ti-6Al-4V flaperon ribs by Direct Energy Deposition (DED). With conventional manufacturing processes, it can be very costly or even impossible to produce components with such complex shapes. However, DED is also challenging due to various features inherent in the design: bulky thin parts, asymmetric geometry, overhanging features etc. The main challenge was manufacturing all the structures with the minimum distortion and highest accuracy.

## WHAT WE DID

First, all the characteristic features of the flaperon rib were identified. An experimental design was then produced to evaluate and optimise the production of those features. All the critical structures such as the overthickness, wall-intersection overlaps or horizontal web welding were therefore optimised before manufacturing the ribs. The design guidelines for critical features for Ti-6Al-4V were developed through this work.

## THE SOLUTION

Three full-scale Ti-6Al-4V ribs were successfully produced by laser powder DED. To reduce the baseplate distortions, a symmetrical build-up was chosen. This strategy helped minimise substrate deformations. For the 15 mm lugs, checkboard deposition with an outside-in strategy was chosen to avoid distortions. In addition, a horizontal plate was welded with DED to create an offset shear web. Thanks to DED, manufacturing the ribs by DED reduced the buy-to-fly ratio from 40 (starting from a titanium block) to 3.



*The MANTA project has received funding from the Clean Sky 2 Joint Undertaking under the European Union's Horizon 2020 research and innovation programme.*

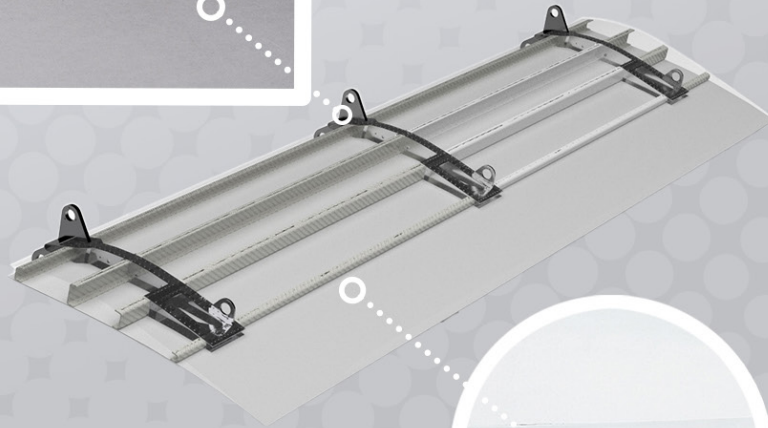
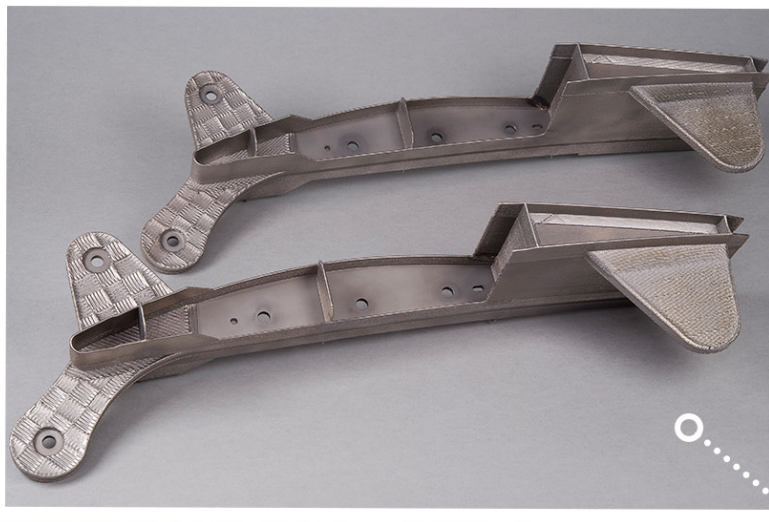

**Project partners:**

Asco, Royal NLR, DLR, TU Delft,  
Fokker Technologies Holding

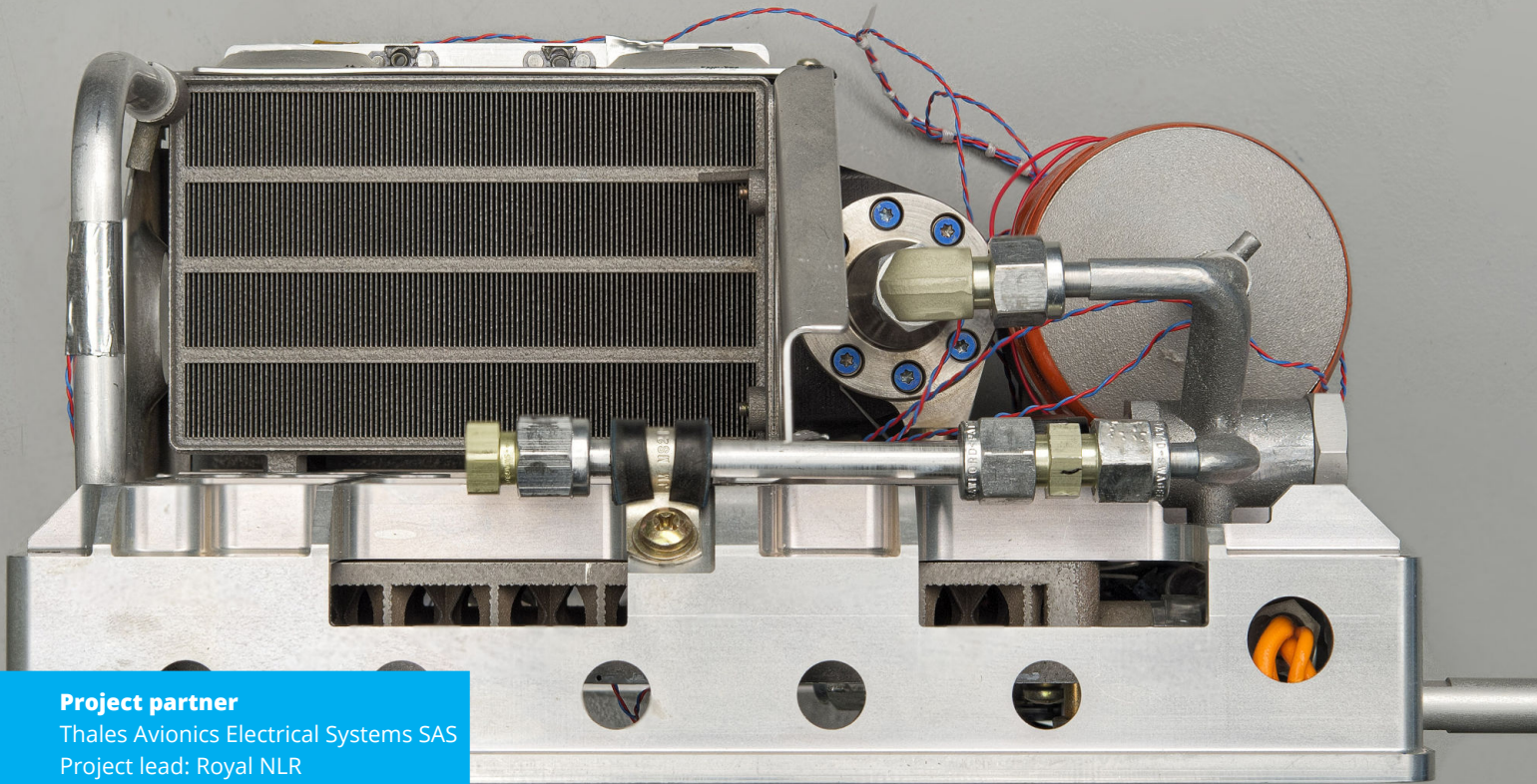

**Project partner**

Thales Avionics Electrical Systems SAS

Project lead: Royal NLR

Duration: 2017 - 2019

# Optimisation of a two-phase cooling solution using a micro-pump brick (TOPMOST)

Modern aircraft and spacecraft rely on growing numbers of onboard electronic components, which in turn are increasingly high-powered and compact. The amount of waste heat that is generated in electronic components in aerospace applications is increasing because of higher electrical power demands. As a result, conventional cooling methods are not able to maintain the electronic component below its maximum temperature. For this reason, a two-phase mechanically pumped fluid loop was developed for high-power electronic components in commercial aerospace applications.

## THE CHALLENGE

Conventional cooling methods have become too large and heavy and have thus become a bottleneck in aerospace systems. In some instances, they cannot supply the required cooling performance and keep devices below their specified maximum temperatures.

## THE SOLUTION

A compact low weight two-phase mechanically pumped fluid loop system was developed. Metal AM was used for producing optimised components to drastically reduce thermal constraints, weight and dimensions. AM offers a great deal of potential for manufacturing these components, given the extensive freedom of design and the ability to create complex internal structures.

## WHAT WE DID?

An alloy was selected using criteria such as thermal conductivity, corrosion resistance, mechanical performance, cost and ease of processing. Parameters were developed that enabled the production of leakproof thin-walled components. Various evaporator concepts were evaluated and component performance tests were carried out. A cooling system was produced and tested. Thermal tests showed that the TOPMOST cooling system can cool a thermal load of 2400W. Thanks to the use of metal AM, a very compact cooling system with an unprecedentedly low mass of 2.5 kg was successfully built.



*The TOPMOST project has received funding from the Clean Sky 2 Joint Undertaking under the European Union's Horizon 2020 research and innovation programme.*

# Aircraft Noise Reduction Technologies and Related Environmental Impact (ARTEM)

## THE CHALLENGE

In recent years, improving energy efficiency (i.e. fuel consumption) and emission reduction have led to increased engine sizes and bypass ratios. These modifications create a crucial noise issue due to the emission of low-frequency noise and the size and effectiveness limitations of the current noise-absorbing structures (liners).

## THE SOLUTION

This project explored innovative ideas and concepts for efficient noise reduction by novel liner concepts. In addition, it investigated the potential of dissipative surfaces as encountered with the development of meta-materials. AM was studied as a potential solution for producing more efficient noise-reduction liners.

Several concepts have been addressed to aim for low-frequency and broad-spectrum absorption. AM opens up new possibilities for manufacturing complicated structures for noise absorbers which have not been technically and/or economically possible before.

## WHAT WE DID?

At NLR-MAMTeC, various acoustic liner prototypes were manufactured with LPBF that were designed by the Institute of Sound and Vibration Research (ISVR). The designs are characterised by the different angled features and hole sizes. The main criterion for the AM part was repeatable quality of the acoustic liners' performance and controllable size of the holes. The liner prototypes were tested in the impedance tube at the Vertical Flight and Aeroacoustics department at NLR. The manufactured liners' performance is in line with the model predictions, although some modifications had to be made to the hole diameters due to the variation between the jobs.



*The ARTEM project has received funding from the European Union's Horizon 2020 research and innovation program (Future Sky EREA initiative).*

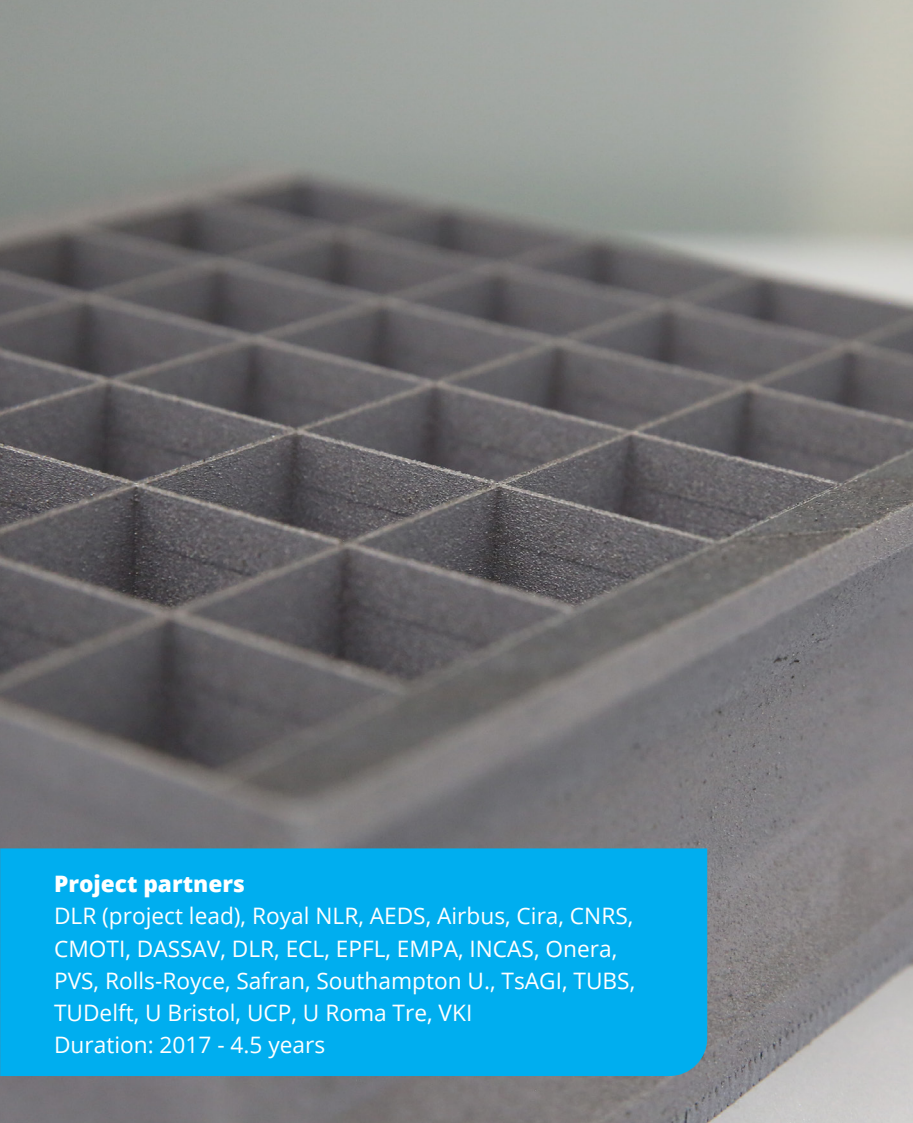

### Project partners

DLR (project lead), Royal NLR, AEDS, Airbus, Cira, CNRS, CMOTI, DASSAV, DLR, ECL, EPFL, EMPA, INCAS, Onera, PVS, Rolls-Royce, Safran, Southampton U., TsAGI, TUBS, TUDelft, U Bristol, UCP, U Roma Tre, VKI  
Duration: 2017 - 4.5 years

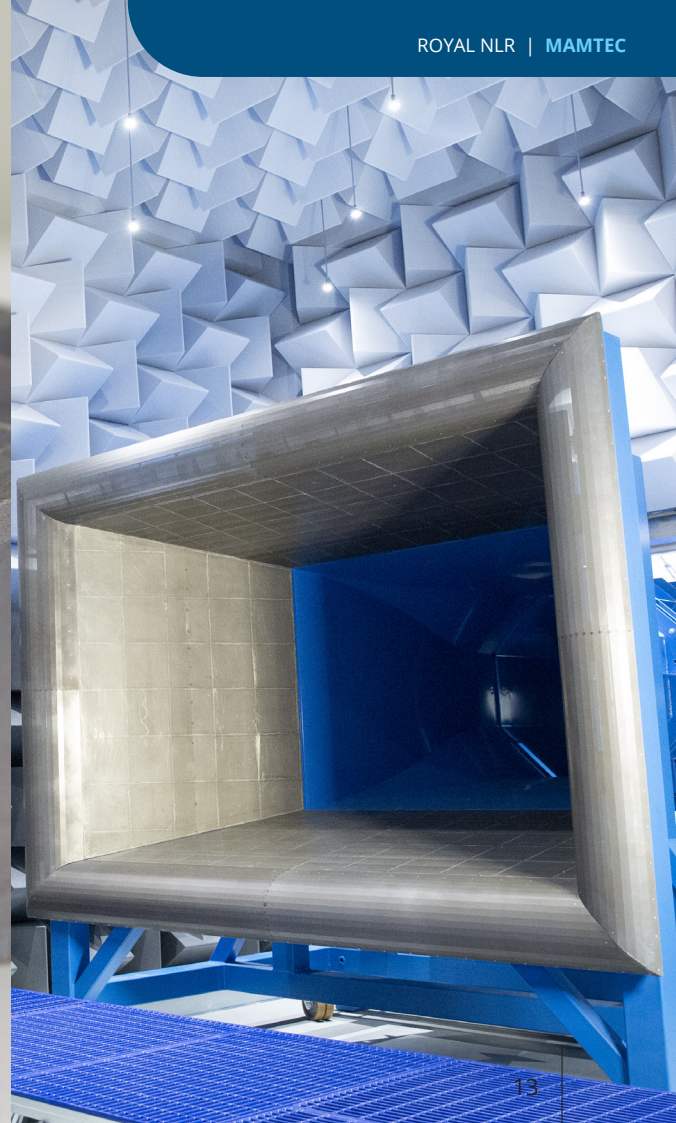

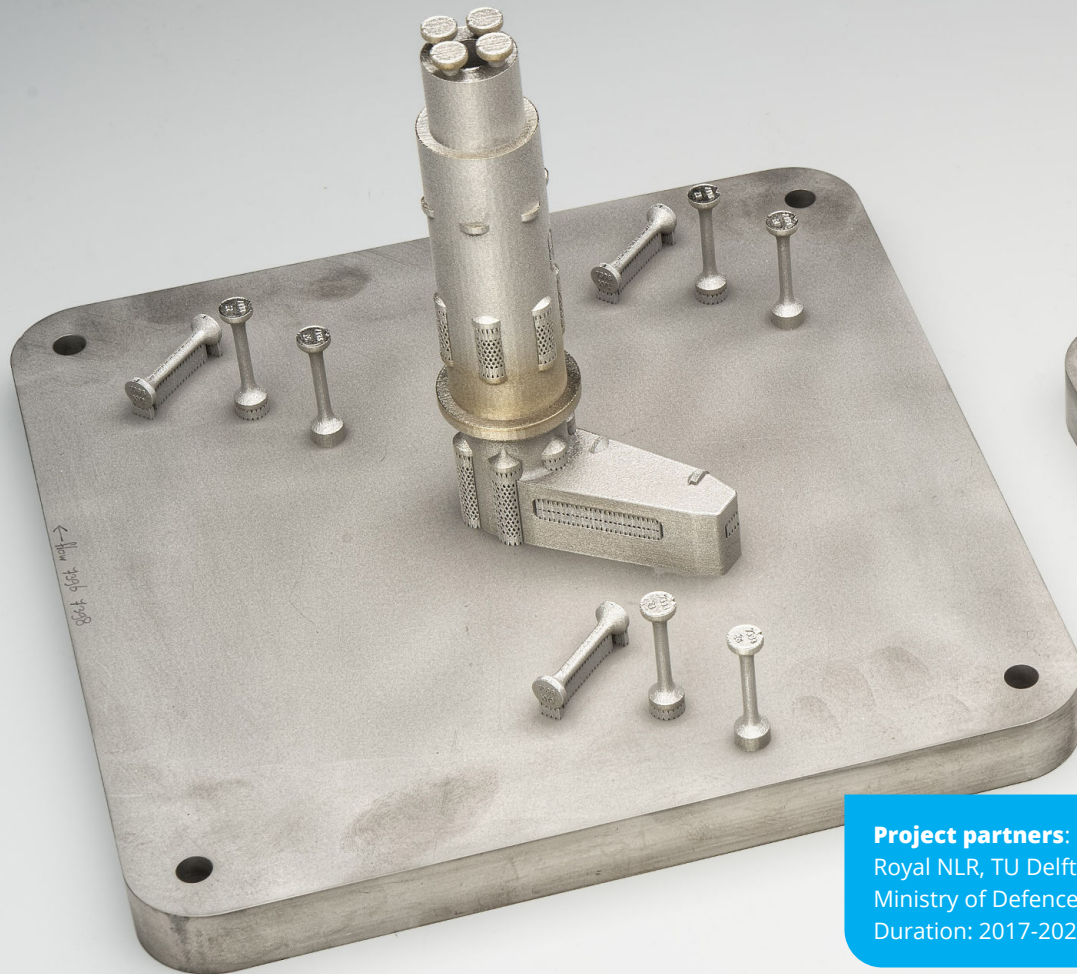

**Project partners:**

Royal NLR, TU Delft, Fokker Aerostructures, BPO,  
Ministry of Defence  
Duration: 2017-2020

# Additive manufacturing and certification of a flight-critical part

The project aims to boost the acceptance of AM technology by producing, certifying and flying a flight-critical AM-produced part. This raises the bar compared to non-flight critical parts, because of the more stringent regulations for flight-critical parts.

## THE CHALLENGE

The goal is to replace an existing conventionally machined flight-critical part with a geometrically identical AM-produced and certified component. Part substitution is not where the AM process has the most significant added value; however, it is the next step in the acceptance of AM technology.

## WHAT WE DID?

The specimen test results are promising and the possibility of certifying the part was deemed realistic, even when accounting for the fact that the test results show significant variation in mechanical properties. However, when evaluating the results in more detail, there were some areas of the build where a strong dependency on location or build-plate configuration was observed. Given that the material properties depend on the position in the building chamber or the presence of other parts in the same build job, it was therefore not possible to

demonstrate with sufficient confidence that the part that was not cut up for inspection would exhibit the same properties and strength values as the samples that were used for determining the strength properties.

## THE SOLUTION

This project has targeted substituting a flight-critical conventionally machined part with a geometrically identical AM-produced part. The layer-by-layer build approach introduces many risks for errors at the micro scale, resulting in variations in material properties, including fatigue. The potential for certifying the part is in sight, but it requires a better understanding and improvement of the AM process to reduce the scatter and improve the material properties.

# Metal Additive Manufacturing Technology Programme, Phase 2

Phase 2 is the follow-up of the successful first metal AM programme which ran from 2015 to 2018. The first programme focussed on laser powder bed fusion (LPBF). The second programme has been extended to include a BeAM Modulo 400 machine dedicated to manufacturing and repairing parts using the Directed Energy Deposition (DED) process.

## **THE CHALLENGE**

The main objective is to assist participants in their goals of introducing certified metal AM parts. Major steps have been made in the past years. The general requirements of the certification authorities were translated into more practical standards for AM by standardisation organisations. Nevertheless, challenges still remain, especially when it comes to more critical AM applications. The current AM qualification approach is 'part based', meaning that the qualification is only valid for a specific part design that is produced using a fixed material on a specific machine using fixed process parameters.

## **WHAT WE ARE DOING?**

The activities in this programme all help the goal of assisting participants achieve the aim of introducing certified metal AM parts. This programme laid the foundations for a simulation-based qualification approach.

## **A BRIEF OVERVIEW OF THE ACTIVITIES:**

### **MATERIALS AND PROCESSES**

Methods were developed for rapid and efficient generation of optimised metal-AM parameters. Static tests and fatigue tests were carried out on various alloys for material characterisation. The effect of typical AM defects on fatigue performance was investigated. The limitations and possibilities of producing multi-material parts with DED were also evaluated, focusing on accurate control of the deposited composition. The quality of the interfaces was evaluated by investigating the cross-sections and the mechanical performance.

### **MODELLING AND SIMULATION**

Thermo-mechanical simulations of the LPBF and DED processes were developed, calibrated and validated. The effect of overheating was studied and various successful strategies were developed to avoid it. In addition, variable process parameter approaches were developed and evaluated to obtain homogeneous microstructures with predictable properties.

## THE SOLUTION

The next step is 'part-family based' qualification, where a group of parts with similar complexity and functional requirements are qualified using the same material and key process parameters. The aim in the end is to develop a process-based qualification approach. This requires an in-depth understanding of the process and the materials produced, as well as the relationship with the part design. Physics-driven models are needed to enable the production of a homogeneous material with predictable properties and process monitoring tools are required to detect when defects are created.

### Project partners:

Royal NLR, AddUp-BeAM, Aeronamic, Dutch Ministry of Defence, Mokveld, Oerlikon, Patria, Shell, Thales Netherlands, Turkish Aerospace Industries TAI

Project leader: NLR

Duration: 2019-2023

# Metal Additive Manufacturing Technology Programme, Phase 2 - Technology demonstrators

## ACTUATOR FITTING FOR A SINGLE-AISLE PASSENGER AIRCRAFT

This actuator fitting was redesigned for LPBF. Furthermore, the material was changed from the reference aluminium to titanium. Using topology optimisation, a structural redesign was carried out including the assembly stiffness (composite structure), print orientation, overhang minimisation and fastener load redistribution. The preliminary and final designs were evaluated using process simulation and these results allowed a distortion compensation to be applied to the printed part. Process optimisation was also carried out for the interlayer waiting time (LT) to prevent overheating.

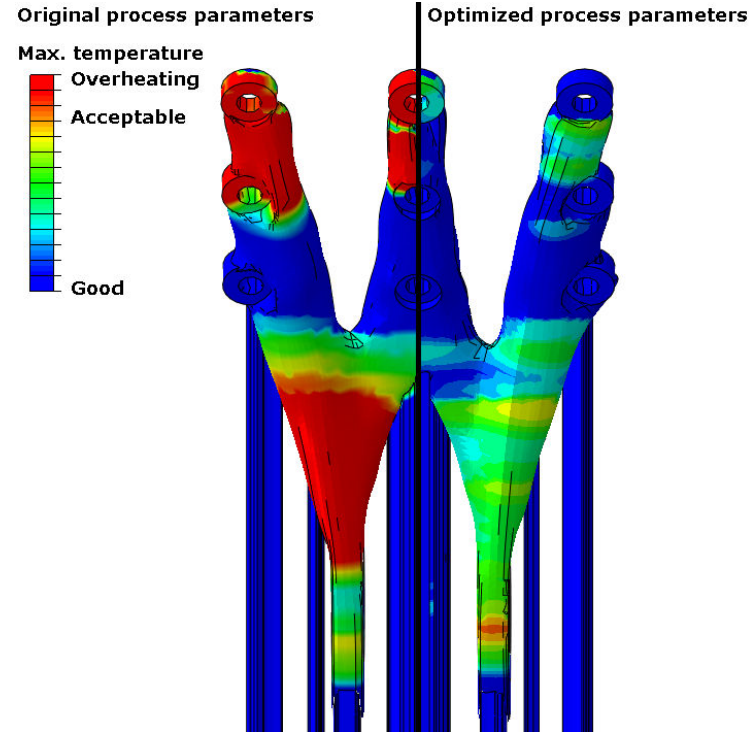

### CHECK VALVE FOR AN OIL AND GAS APPLICATION

The check valve demonstrator is a challenging multi-material component in which multiple metal-AM processes have also been combined. A complex internal structure is produced by LPBF. A larger volume multi-material section is produced by Laser Powder

DED. Finally, the application of flanges using wire-based processes is being investigated. An alloy with high corrosion resistance on the inside of this demonstrator is combined with a medium-strength and low-cost material on the outside.

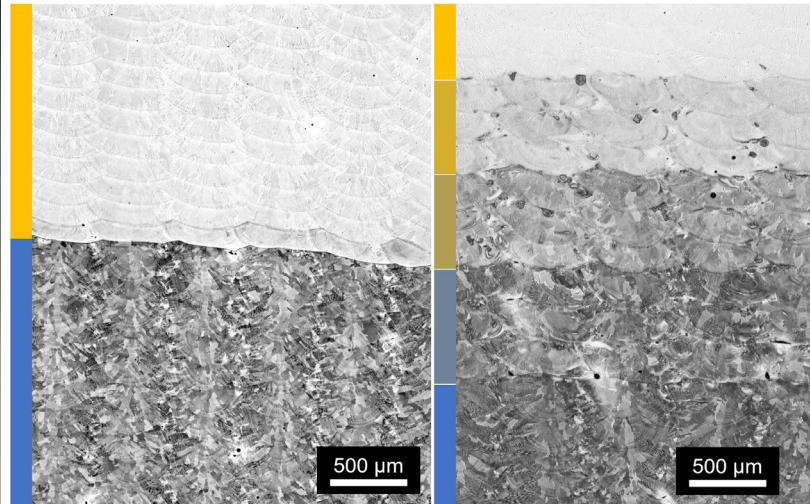
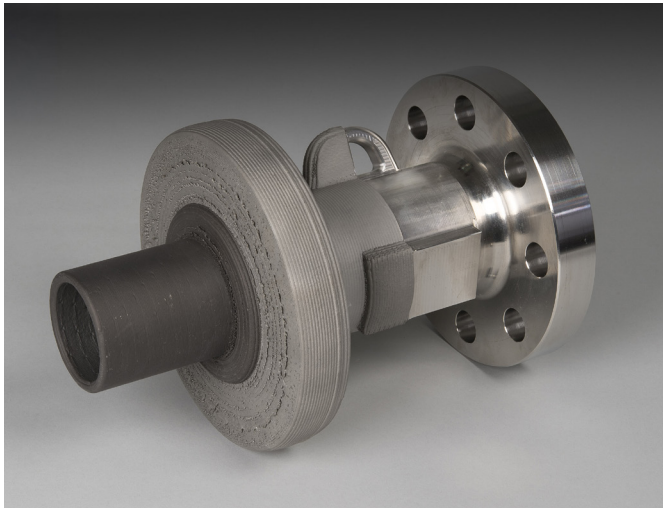

## MAMTeC facility

*Technologies and Materials*

*NLR-MAMTeC has:*

- *Laser Powder Bed Fusion (LPBF)*
- *Blown Powder Directed Energy Deposition (manufacturing & repairs)*
- *Sinter-based fused filament fabrication*
- *Materials laboratories and research & testing facilities*





# Royal NLR in brief



One-stop-shop



Global player with Dutch roots

100+

Since 1919



Amsterdam, Marknesse  
Rotterdam, Noordwijk, Brussel



Innovative, involved  
and practical



For industry and  
governmental



For civil and  
defence



800+  
staff



€ 127 M turnover



78% Dutch, 19% EU  
and 3% worldwide



Active in 24 countries



Very high  
customer satisfaction

# About NLR

## Royal Netherlands Aerospace Centre

NLR is a leading international research centre for aerospace. Its mission is to make air transport safer, more efficient, more effective and more sustainable. Bolstered by its multidisciplinary expertise and unrivalled research facilities, NLR provides innovative and comprehensive solutions to the complex challenges of the aerospace sector.

NLR's activities span the full spectrum of Research, Development, Testing & Evaluation (RDT & E). Given NLR's specialist knowledge and state-of-the-art facilities, companies turn to NLR for validation, verification, qualification, simulation and evaluation. They also turn to NLR because of its deep engagement with the challenges facing our clients. In this way, NLR bridges the gap between research and practical applications, while working for both government and industry at home and abroad.

Royal NLR stands for practical and innovative solutions, technical expertise and a long-term design vision, regarding their fixed wing aircraft, helicopter, drones and space exploration projects. This allows NLR's cutting-edge technology to find its way also into successful aerospace programmes of OEMs like Airbus, Boeing and Embraer.

NLR-MAMTeC is the independent Metal Additive Manufacturing Technology Centre in the Netherlands and it is part of the Royal NLR. More than 50 years of materials experience in aerospace applications is applied, offering assistance through technology development and product innovation. Our multidisciplinary team can help you develop the process more efficiently, from optimised parameters, post-processing approaches, evaluation of mechanical properties, design optimisation and process simulation through to the qualification and certification of metal-additive manufacturing (AM) products.

For more information:

Marc de Smit  
marc.de.smit@nlr.nl

Vis Dhanisetty  
vis.dhanisetty@nlr.nl

#### **NLR Amsterdam**

Anthony Fokkerweg 2  
1059 CM Amsterdam

☎ +31 88 511 3113

✉ [info@nlr.nl](mailto:info@nlr.nl) 🌐 [www.nlr.org](http://www.nlr.org)

#### **NLR Marknesse**

Voorsterweg 31  
8316 PR Marknesse

☎ +31 88 511 4444

✉ [info@nlr.nl](mailto:info@nlr.nl) 🌐 [www.nlr.org](http://www.nlr.org)

